

## Gear pump unit with reservoir for use in centralized lubrication systems

Product series:

KFB1-M.., KFB1-W.., KFB1-M-W..

KFBS1-M.., KFBS1-W.., KFBS1-M-W..



Owner's Manual - Containing Installation,  
Operation and Maintenance Instructions  
(Original installation instructions in accordance with EC-  
Machinery Directive 2006/42/EC)

Version 05

### WARNING:

Read this owner's manual before installing, operating or maintaining the product. Failure to follow the instructions and safety precautions in this owner's manual could result in serious injury, death, or property damage. Keep for future reference.



## Masthead

This owner's manual – containing installation, operation and maintenance instructions complies with EC-Machinery Directive 2006/42/EC and is an integral part of the described product. It must be kept for future use.

This owner's manual – containing installation, operation and maintenance instructions was created in accordance with the valid standards and regulations on documentation, VDI 4500 and EN 292.

### © SKF Lubrication Systems Germany GmbH

This documentation is protected by copyright. The photomechanical reproduction, copying, and distribution of this documentation or parts thereof by means of processes such as data processing, data carriers, and data networks is strictly prohibited without the express permission of SKF Lubrication Systems Germany GmbH.

SKF Lubrication Systems Germany GmbH reserves the right to make content and technical changes.

## Service

If you have technical questions, please contact the following offices:

### SKF Lubrication Systems Germany GmbH

Berlin Plant  
Motzener Strasse 35/37  
12277 Berlin  
Germany  
Tel. +49 (0)30 72002-0  
Fax +49 (0)30 72002-111

Hockenheim Plant  
2. Industriestrasse 4  
68766 Hockenheim  
Germany  
Tel. +49 (0)62 05 27-0  
Fax +49 (0)62 05 27-101





[lubrication-germany@skf.com](mailto:lubrication-germany@skf.com)  
[www.skf.com/lubrication](http://www.skf.com/lubrication)

# Table of contents

## Owner's Manual – Containing Installation, Operation and Maintenance Instructions

(Original installation instructions in accordance with  
EC-Machinery Directive 2006/42/EC)

<b>Masthead</b> .....	2
<b>Service</b> .....	2
<b>Table of contents</b> .....	3
<b>Information concerning EC Declaration of Incorporation</b> .....	6
<b>General information</b> .....	7
Explanation of safety and informational symbols and safety signal words .....	7
<b>1. Safety instructions</b> .....	8
1.1. Intended use.....	8
1.2. Authorized personnel .....	8
1.3. Electric shock hazard .....	9
1.4. System pressure hazard .....	9
1.5. Warranty and liability .....	9
<b>2. Lubricants</b> .....	10
2.1. General information.....	10
2.2. Selection of lubricants .....	10
2.3. Approved lubricants .....	11
2.4. Lubricants and the environment.....	11
2.5. Lubricant hazards.....	11
<b>3. Design and function</b> .....	12
3.1. Field of application and design .....	12
3.2. Function .....	15
3.2.1. Lubrication cycle of prelubrication distributor .....	15

3.2.2. Lubrication cycle of relubrication distributor.....	15
3.3. Pressure regulating valve .....	15
3.4. Fill level monitoring.....	15
3.4.1. Visual.....	15
3.4.2. Fill level switch.....	15
3.5. Gear pump units with external control unit (KFB1).....	16
3.6. Gear pump units with internal control unit (KFBS1).....	16
3.6.1. The lubrication cycle.....	16
3.6.2. The interval time.....	16
3.6.3. The contact time .....	16
3.6.4. Modes of operation.....	16
3.6.5. Monitoring an external pressure switch .....	16
3.6.6. Fill level monitoring.....	17
3.6.7. System monitoring.....	17
3.6.8. EEPROM non-volatile memory.....	17
3.6.9. Code protection .....	17
<b>4. Assembly instructions</b> .....	18
4.1. General information .....	18
4.2. Setup and attachment.....	18
4.3. Connection dimensions.....	19
4.4. Electrical connection.....	20
4.4.1. Electric motor connection .....	20
4.4.2. KFB1 (commercial vehicles).....	21
4.4.3. KFB1-W (commercial vehicles).....	22
4.4.4. KFBS1, KFBS1-W (commercial vehicles).....	23
4.4.5. KFB1-M (industrial).....	24
4.4.6. KFB1-M-W (industrial).....	25
4.4.7. KFBS1-M, KFBS1-M-W.....	26
4.5. Lubrication line connection.....	27
4.6. Lubrication line arrangement .....	27
<b>5. Transport, delivery, and storage</b> .....	29
5.1. Transport .....	29
5.2. Delivery.....	29
5.3. Storage.....	29
5.3.1. Storage of lubrication units .....	29
5.3.2. Storage of electronic and electrical devices .....	29
5.3.3. Storage - general information.....	29
<b>6. Operation</b> .....	30
6.1. General information.....	30
6.2. Filling the lubricant reservoir .....	30
6.3. Vent centralized lubrication system.....	30
<b>7. Operation</b> .....	32
7.1. Gear pump units without internal control unit .....	32
7.2. Gear pump units with internal control unit .....	32
<b>8. Electronic control unit</b> .....	33
8.1. Display and control elements.....	33
8.2. Pushbutton operation.....	33
8.2.1. Button  (OK).....	33
8.2.2. Button  (UP).....	33
8.2.3. Button  (DOWN).....	33
8.2.4. Button  (SET).....	33
8.3. Programming .....	37
8.3.1. Start programming mode.....	37
8.3.2. Change operating mode .....	38
8.3.3. Set interval time and contact time.....	39
8.3.4. Switch monitoring function on/off .....	40
8.3.5. Change programming code .....	41
8.4. Operation.....	42
8.4.1. LED displays on the control screen during operation .....	42

8.4.2. Display mode .....	43
8.5. Faults .....	45
8.5.1. Display of faults.....	45
8.5.2. Clear fault messages.....	45
8.5.3. Fault hour meter .....	45
<b>9. Shutdown .....</b>	<b>46</b>
9.1. Temporary shutdown .....	46
9.2. Permanent shutdown .....	46
<b>10. Maintenance .....</b>	<b>47</b>
10.1. General notes .....	47
10.2. Cleaning .....	47
<b>11. Faults .....</b>	<b>48</b>
11.1. Fault indications on gear pump units without control unit.....	48
11.1.1. Gear pump units without fill level monitoring (KFB) .....	48
11.1.2. Gear pump units with integrated fill level monitoring (KFB.-W) .....	48
11.2. Fault analysis and rectification.....	48
<b>12. Technical data.....</b>	<b>50</b>

Blank page

## Information concerning EC Declaration of Incorporation

The product

### Gear pump unit with reservoir

Product line:

**KFB1-M.., KFB1-W.., KFB1-M-W..  
KFB1S-M.., KFB1S-W.., KFB1S-M-W..**

SKF herewith certifies that it conforms to the pertinent safety requirements set forth in the following Council Directive(s) for the harmonisation of the laws of the Member States...

- **Machinery Directive 2006/42/EC**
- **Electromagnetic compatibility 2014/30/EU**
- **Electromagnetic compatibility 2004/104/EU**
- **RoHS Directive 2011/65/EU**

SKF further declares that the above mentioned product is meant for integration into a machinery / for connection to other machinery according to the **EC-Machinery Directive 2006/42/EC, Appendix II Part B**. Starting up the product is not permissible until it is assured that the machinery, vehicle or the like in which the product was installed meets the provisions and requirements of the regulations set forth in the EC Directive 2006/42/EC.

#### Notes:

- (a) This declaration certifies conformity with the aforementioned directive(s), but does not contain any assurance of properties.
- (b) The safety instructions in the owner's manual must be observed.
- (c) The certified product must not be started up until it is confirmed that the equipment, machinery, vehicle or the like in which the product was installed meets the provisions and requirements of the national directives to be applied. This is in particular important for the implementation of the Use of Work Directive.
- (d) Operation of the products on non-standard main voltage as well as nonobservance of installation instructions can affect the EMC properties and electrical safety.

#### Notes on the Pressure Equipment Directive 2014/68/EU

Due to its performance characteristics, the product does not reach the limit values defined in Article 4, Paragraph 1, Subparagraph (a) item (i) and is, pursuant to Article 4, Paragraph 3, excluded from the scope of Pressure Equipment Directive 2014/68/EU.

The EC Declaration of Incorporation is part of the product documentation. This document is delivered with the product.

## General information

Explanation of safety and informational symbols and safety signal words

You will find these symbols, which warn of specific dangers to persons, material assets, or the environment, next to all safety instructions in this owner's manual.

Please heed these instructions and proceed with special care in such cases. Please pass all safety instructions to other users.

Instructions attached directly to the equipment, such as rotational direction arrows and fluid connection labels, must be followed. Replace such signs if they become illegible.

- Rotational direction arrow
- Fluid connection label



**You are responsible!**

Please read the owner's manual thoroughly and follow the safety instructions.

### Note

Not every symbol and corresponding information described in the Safety Information is necessarily used in these instructions.

**Table 1. Hazard symbols**

Symbol	Standard	Meaning
	DIN 4844-2 W000	General hazard
	DIN 4844-2 W008	Voltage
	DIN 4844-2 W026	Hot surface
	DIN 4844-2 W028	Slip hazard

**Table 2. Safety signal words and their meaning**

Signal word	Meaning
Danger!	Danger of bodily injury
Warning!	Danger of damage to property or the environment
Note	Additional information

**Table 3. Informational symbols**

Symbol	Meaning
	Note
•	Prompts an action
○	Used for itemizing
➔	Refers to other facts, causes or consequences
	Provides additional information

## 1. Safety instructions



The operator of the described product must ensure that the owner's manual is read and understood by all persons tasked with the assembly, operation, maintenance, and repair of the product. The owner's manual must be kept readily available.



Note that the owner's manual forms part of the product and must accompany the product if sold to a new owner.

The described product is manufactured in accordance with the generally accepted rules and standards of industry practice and with occupational safety and accident prevention regulations. Risks may, however, arise from its usage and may result in physical harm to persons or damage to other material assets. Therefore the product may only be used in proper technical condition and in observance of the owner's manual. In particular, any malfunctions which may affect safety must be remedied immediately.



In addition to the owner's manual, statutory regulations and other general regulations for accident prevention and environmental protection must be observed and applied.

### 1.1. Intended use



All products from SKF Lubrication Systems Germany GmbH may be used only for their intended purpose and in accordance with the information in the product's owner's manual.

The described product is for supplying centralized lubrication systems with lubricant and is intended for use in centralized lubrication systems. Any other use of this product constitutes improper use.

Hazardous materials of any kind, especially the materials classified as hazardous by CLP Regulation EC 1272/2008 may only be used to fill SKF centralized lubrication systems and components and delivered and/or distributed with the same after consulting with and receiving written approval from SKF.

The described product is neither designed nor approved for use in conjunction with gases, liquefied gases, pressurized gases in solution, vapors or such fluids whose vapor pressure exceeds normal atmospheric pressure (1013 mbar) by more than 0.5 bar at their maximum permissible temperature.

Unless otherwise noted, products of SKF Lubrication Systems Germany GmbH must not be used in conjunction with explosive atmospheres according to the ATEX-Directive 94/9/EC.

### 1.2. Authorized personnel

The products described in the installation instructions may only be installed, operated, maintained, and repaired by qualified experts. Qualified experts are persons who have been trained, instructed, and familiarized with the end product into which the described product is installed. These persons are considered capable of such tasks due to their education, training, and experience with valid standards, conditions, accident prevention regulations, and installation measures. They should be able to carry out the required tasks and to recognize – and thus avoid – any dangers that might otherwise occur.

A definition of what constitutes a qualified person and who are unqualified persons are stipulated in DIN VDE 0105 and IEC 364.



### 1.3. Electric shock hazard

Electrical connections for the described product may only be established by qualified and trained personnel authorized to do so by the operator, and in observance of the local conditions for connections and local regulations (e.g., DIN, VDE). Serious injury or death and property damage may result from improperly connected products.

**Danger!**

Performing work on an energized pump or product may result in serious injury or death. Assembly, maintenance, and repair work may only be performed on products that have been de-energized by qualified technical personnel. The supply voltage must be switched off before opening any of the product's components.

### 1.4. System pressure hazard

**Danger!**

Centralized lubrication systems are pressurized during operation. Centralized lubrication systems must therefore be depressurized before starting assembly, maintenance or repair work, or any system modifications or system repairs.

### 1.5. Warranty and liability

SKF Lubrication Systems Germany GmbH assumes no warranty or liability for the following:

- Non-compliant usage
- Improper assembly/disassembly or improper operation
- Use of unsuitable or contaminated lubricants
- Maintenance and repair work performed improperly or not performed at all
- Use of non-original SKF spare parts
- Alterations or modifications performed without written approval from SKF Lubrication Systems Germany GmbH
- Non-compliance with the instructions for transport and storage

## 2. Lubricants

### 2.1. General information



All products from SKF Lubrication Systems Germany GmbH may be used only for their intended purpose and in accordance with the information in the product's owner's manual.

Intended use is the use of the products for the purpose of providing centralized lubrication/lubrication of bearings and friction points using lubricants within the physical usage limits which can be found in the documentation for the device, e.g. owner's manual/operating instructions and the product descriptions, e.g. technical drawings and catalogs.

Particular attention is called to the fact that hazardous materials of any kind, especially those materials classified as hazardous by EC Directive 67/548/EEC, Article 2, Para. 2, may only be filled into centralized lubrication systems and components and delivered and/or distributed with such systems and components after consulting with and obtaining written approval from SKF Lubrication Systems Germany GmbH.

No products manufactured by SKF Lubrication Systems Germany GmbH are approved for use in conjunction with gases, liquefied gases, pressurized gases in solution, vapors, or such fluids whose vapor pressure exceeds normal atmospheric pressure

(1013 mbar) by more than 0.5 bar at their maximum permissible temperature.

Other media which are neither lubricant nor hazardous substance may only be fed after consulting with and obtaining written approval from SKF Lubrication Systems Germany GmbH.

SKF Lubrication Systems Germany GmbH considers lubricants to be a component of the system design and must be factored into the selection of components and the design of centralized lubrication systems. The lubricating properties of the lubricants are critically important in making these selections.

### 2.2. Selection of lubricants



#### Warning!

The amount of lubricant required at a lubrication point is specified by the bearing or machine manufacturer. It must be ensured that the required quantity of lubricant is provided to the lubrication point. The lubrication point may otherwise not receive adequate lubrication, which can lead to damage and failure of the bearing.



Observe the instructions from the machine manufacturer regarding the lubricants that are to be used.

The selection of a lubricant suitable for the lubrication task is made by the machine/system manufacturer and/or the operator of the

machine/system in cooperation with the lubricant supplier. When selecting a lubricant, the type of bearing/friction point, the expected load during operation, and the anticipated ambient conditions must be taken into account. All economic and environmental aspects must also be considered.



If required, SKF Lubrication Systems Germany GmbH can help customers to select suitable components for the conveyance of the selected lubricant and to plan and design their centralized lubrication system.

Please contact SKF Lubrication Systems Germany GmbH if you have further questions regarding lubricants. Lubricants can be tested in the company's laboratory for their suitability for pumping in centralized lubrication systems (e.g., "bleeding").

You can request an overview of the lubricant tests offered by SKF Lubrication Systems Germany GmbH from the company's Service department.

### 2.3. Approved lubricants

**Warning!**

Only lubricants approved for the product may be used. Unsuitable lubricants can lead to failure of the product and damage to property.

**Warning!**

Different lubricants must not be mixed together. Doing so can cause damage and require extensive cleaning of the product/centralized lubrication system. It is recommended that an indication of the lubricant in use be attached to the lubricant reservoir in order to prevent accidental mixing of lubricants.

The described product can be operated using lubricants that meet the specifications in the technical data.

Note that in rare cases, there may be lubricants whose properties are within the permissible limits values but whose other characteristics render them unsuitable for use in centralized lubrication systems. For example, synthetic lubricants may be incompatible with elastomers.

### 2.4. Lubricants and the environment

**Warning!**

Lubricants can contaminate soil and bodies of water. Lubricants must be used and disposed of properly. Observe the local regulations and laws regarding the disposal of lubricants.

It is important to note that lubricants are environmentally hazardous, flammable substances that require special precautionary measures during transport, storage, and processing. Consult the safety data sheet from the lubricant manufacturer for information regarding transport, storage, processing, and environmental hazards of the lubricant that will be used. The safety data sheet for a lubricant can be requested from the lubricant manufacturer.

### 2.5. Lubricant hazards

**Danger!**

Centralized lubrication systems must always be free of leaks. Leaking lubricant is hazardous due to the risk of slipping and injury. Beware of any lubricant leaking out during assembly, operation, maintenance, or repair of centralized lubrication systems. Leaks must be sealed without delay.

Lubricant leaking from centralized lubrication systems is a serious hazard. Leaking lubricant can create risks that may result in physical harm to persons or damage to other material assets.



Follow the safety instructions on the lubricant's safety data sheet.

Lubricants are hazardous substances. The safety instructions on the lubricant's safety data sheet must be strictly followed. The safety data sheet for a lubricant can be requested from the lubricant manufacturer.

## 3. Design and function

### 3.1. Field of application and design

SKF gear pump units with reservoir of the KFB1 and KFBS1 series are used to supply lubricant to centralized lubrication systems in commercial vehicles, systems, and machines. Gear pump units with reservoir are designed to deliver fluid greases of NGLI Grades 000 to 00.

Gear pump units with reservoir differ in the way they can be electrically connected as well as in the control and function monitoring (➔ Table 4).

➔ Fig. 1 and ➔ Fig. 2 show the structure of the gear pump units with reservoir, with the KFB1 and KFBS1 series as examples.

Gear pump units with reservoir consist of the following components: Item 1 indicates the

connecting plate to which the pressure regulating valve (6), the pressure relief valve (not shown), the filler coupling (5) and the lubrication line connection (10) are mounted.

The pump housing (2) contains the mounting flange (4), the control screen (item 8, Fig. 2, only KFBS1), and the electrical connection (9). Gear pump units with reservoir of series KFB1 do not have a control screen; they are equipped with a pushbutton to trigger an interim lubrication (item 7, Fig. 1).

The lubricant reservoir (3) is installed on the pump housing. The lubricant reservoir is made of transparent plastic with fill level markings for visual monitoring of the fill level. Model designs with fill level monitoring are equipped with a follower piston in the lubricant reservoir.

**Table 4. Model designs of gear pump unit with reservoir of series KFB1 and KFBS1**

Description	Application	Control	Piston distributor	Function	
KFB1+912/+924	Commercial vehicle, 12 / 24 V DC	external	none	Basic design without control unit	
KFB1-4-S1+912/+924			4-port		
KFB1-6-S1+912/+924			6-port		
KFB1-W+912/+924			none	With fill level monitoring	
KFB1-W-4-S1+912/+924			4-port		
KFB1-W-6-S1+912/+924			6-port		
KFBS1+912/+924		internal	external	none	Basic design with control unit and monitoring for external pressure switch
KFBS1-4-S1+912/+924				4-port	
KFBS1-6-S1+912/+924				6-port	
KFBS1-W+912/+924			none	With fill level monitoring, with monitoring for external pressure switch	
KFBS1-W-4-S1+912/+924			4-port		
KFBS1-W-6-S1+912/+924			6-port		
KFB1-M+924	Industrial, 24V DC	external	none	Basic design without control unit	
KFB1-M-W+924				With fill level monitoring	
KFBS1-M+924		internal		Basic design with control unit	
KFBS1-M-W+924				With fill level monitoring	

**Fig. 1. Structure of KFB1, schematic diagram, subject to changes**

- 1 Connecting plate
- 2 Pump housing
- 3 Lubricant reservoir
- 4 Mounting flange
- 5 Filler coupling
- 6 Pressure regulating valve
- 7 Pushbutton to trigger an interim lubrication (only KFB1)
- 9 Electrical connections
- 10 Lubrication line connection

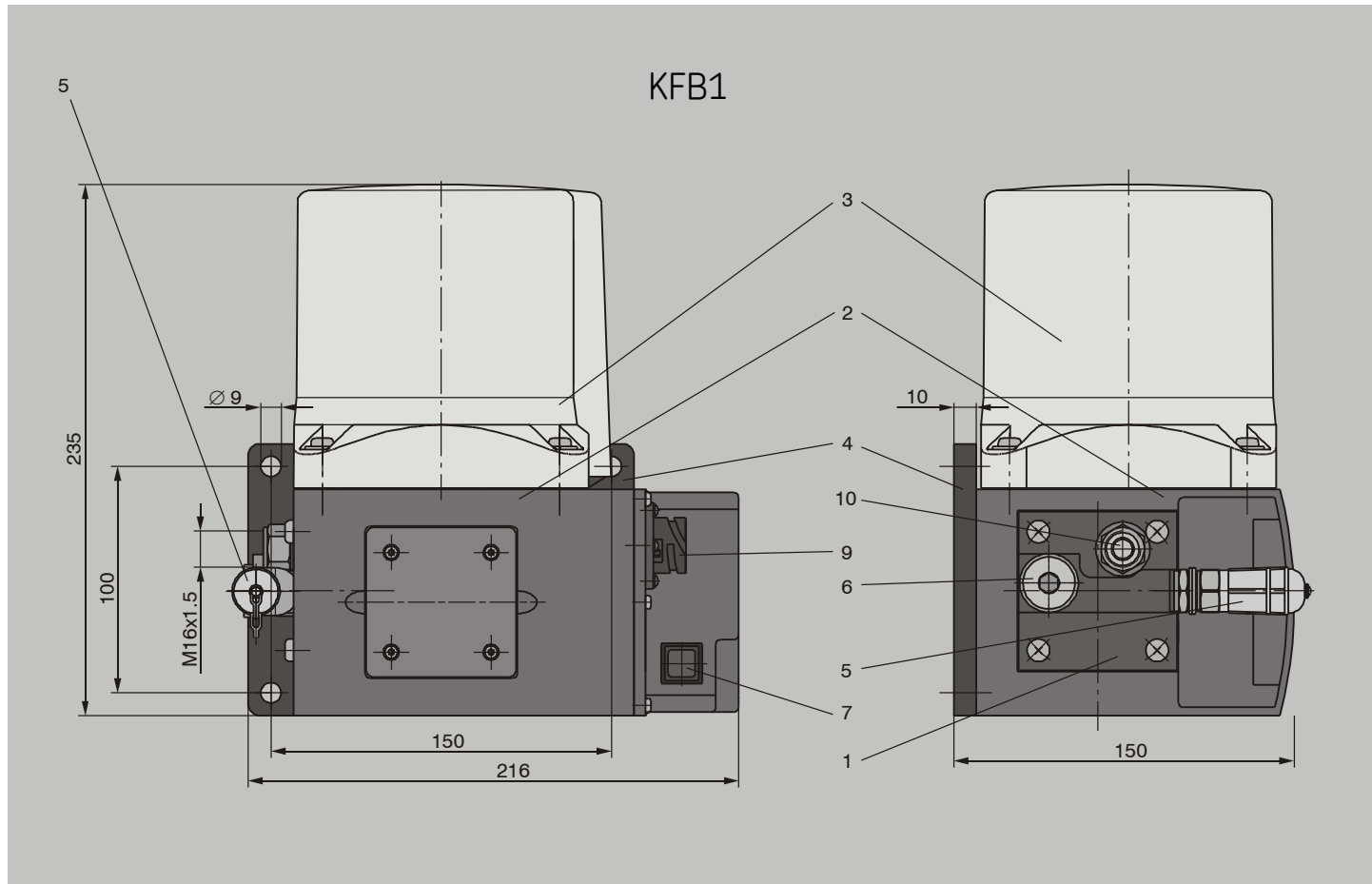

KFBS1

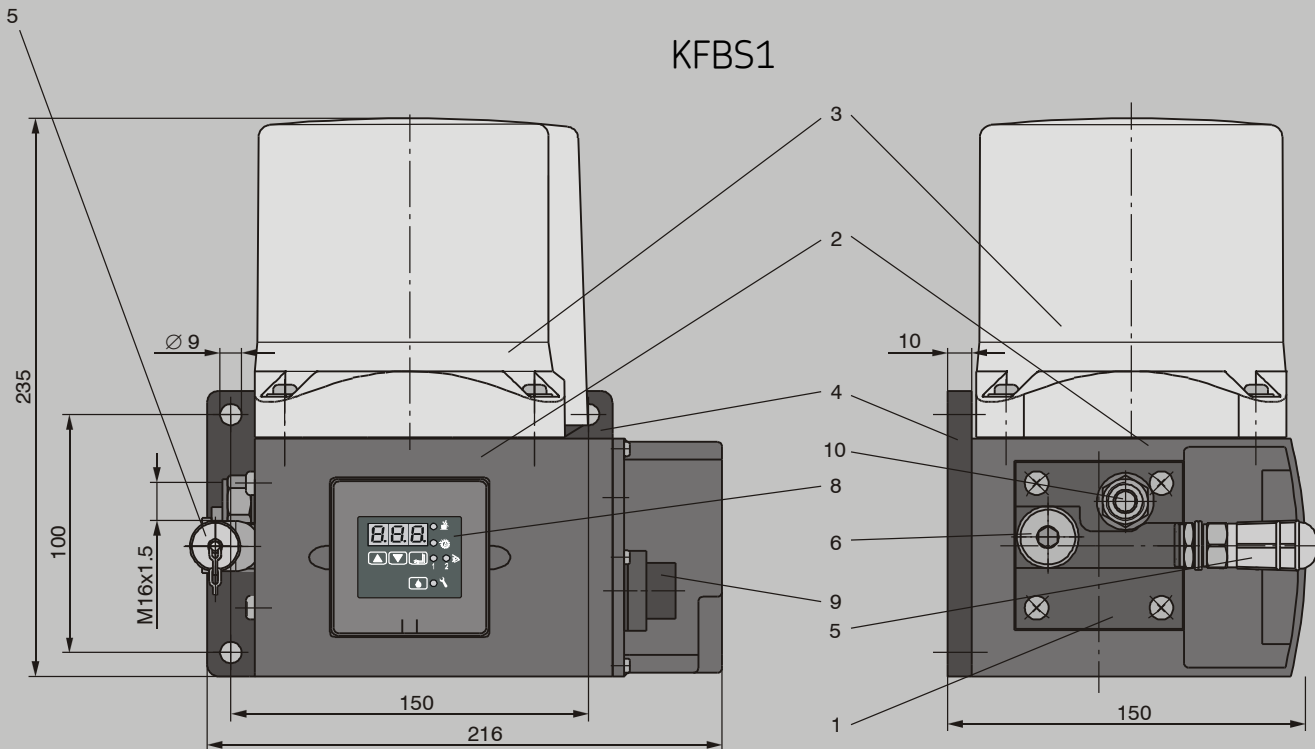

## 3.2. Function

### 3.2.1. Lubrication cycle of prelubrication distributor

After the electric motor is switched on, the lubricant is drawn out of the lubricant reservoir by the gear pump and fed through the lubricant line to the relubrication distributors via the pressure relief valve and the pressure regulating valve. The pressure built up in the centralized lubrication system meters the lubricant separately for each lubrication point and feeds it to the consuming points. After the electric motor is switched off, the pressure is relieved in the centralized lubrication system. In this process, the lubricant is moved within the prelubrication distributor from the spring chamber into the metering chamber. The centralized lubrication system is ready for the next lubrication cycle.

**Fig. 2. Structure of KFBS1, schematic diagram, subject to changes**

- 1 Connecting plate
- 2 Pump housing
- 3 Lubricant reservoir
- 4 Mounting flange
- 5 Filler coupling
- 6 Pressure regulating valve
- 8 Control screen (only KFBS)
- 9 Electrical connections
- 10 Lubrication line connection

### 3.2.2. Lubrication cycle of relubrication distributor

After the electric motor is switched on, the lubricant is drawn out of the lubricant reservoir by the gear pump and fed through the lubricant line to the relubrication distributors via the pressure relief valve and the pressure regulating valve. The pressure built up in the centralized lubrication system feeds the lubricant into the storage chamber of the relubrication distributors. After the electric motor is switched off, the pressure is relieved in the centralized lubrication system. In this process, the lubricant is metered within the relubrication distributor and delivered to the lubrication point (relubrication effect). After the lubricant has been completely expelled to the lubrication point, the centralized lubrication system is ready for the next lubrication cycle.

## 3.3. Pressure regulating valve

The integrated pressure regulating valve prevents excessive pressure in the entire lubrication system.

If the operating pressure exceeds the cracking pressure of the pressure regulating valve, the valve opens and the lubricant is returned to the lubricant reservoir.

## 3.4. Fill level monitoring

### 3.4.1. Visual



#### **Danger!**

The fill level in the lubricant reservoir must be checked regularly on gear pump units without integrated fill level monitoring. Proper lubrication is no longer guaranteed if the fill level falls below the "min." mark, which can result in severe injury or death and property damage.



The entire centralized lubrication system must be vented if the lubricant reservoir fill level has fallen below the "min." mark.

The lubricant reservoir is transparent and has marks indicating the maximum and minimum fill level.

### 3.4.2. Fill level switch

Gear pump units with reservoir can optionally be equipped with a fill level switch. When the fill level in the lubricant reservoir reaches the "min." mark, one of the following occurs depending on the model design:

- On gear pump units with integrated control unit, the operational sequence is stopped and a fault message appears on the control screen.
- On gear pump units without control unit, the signal is issued via the corresponding connector so that it can be evaluated by an external control unit or the machine control unit.

### 3.5. Gear pump units with external control unit (KFB1)

On gear pump units without internal control unit, the contact and interval times (→ next chapter) are controlled and the lubrication process is monitored by an external control unit or by the machine's control unit connected to the gear pump unit. SKF offers the IG502-2-E control unit for use in commercial vehicles (KFB1, KFB1-W). Gear pump units for industrial applications (KFB1-M and KFB1MW) are connected to the machine control unit.

Observe the operating instructions of an external control unit, if used. For the permissible setting range for interval and contact times, consult the "Technical data" (→ Chapter 12) or the associated documentation.



If no documentation is available, you can request the documentation directly from SKF Lubrication Systems Germany GmbH.

### 3.6. Gear pump units with internal control unit (KFBS1)

Gear pump units with internal control unit possess an integrated programmable control unit that controls the functions of the gear pump unit and handles monitoring of the fill level switch and an external pressure switch.

#### 3.6.1. The lubrication cycle

A lubrication cycle is comprised of the interval time and the contact time.

#### 3.6.2. The interval time

The interval time is the time between two contact times. The length of the interval time can be defined in two ways, providing two different control modes: → timer mode and → counter mode.

#### 3.6.3. The contact time

Once the interval time is finished, the control unit initiates the lubrication procedure (also called "contact time"). The operator can set the duration of the contact time, and can change between timer mode and counter mode.

#### 3.6.4. Modes of operation

The gear pump unit can be operated in two different modes:

##### Timer mode

The lengths of the interval time and contact time are timer-controlled. The operator can set the duration of the interval time and the contact time.

##### Counter mode

The duration of the interval time and the contact time (if applicable) depends on the number of pulses. This means that an external pulse generator sends pulses to the control unit based on machine operation. The control unit registers the pulses. The length of the interval time and/or contact time depends on the number of received pulses as set by the operator.



Changeover of contact time to counter mode is reserved for special cases. Please contact SKF.

#### 3.6.5. Monitoring an external pressure switch

On gear pump units with integrated control unit, an external pressure switch contained in the main lubricant line can be monitored. This function is used to monitor pressure build-up in the centralized lubrication system. See the associated documentation for additional information.



If no documentation is available, you can request the documentation directly from SKF Lubrication Systems Germany GmbH.

During the contact time, the gear pump motor first starts and the pressure required for lubrication is built up. The external pressure switch is queried after the time required for pressure build-up has elapsed. If the required pressure has not been reached, the gear pump unit is switched off and a fault message is issued.



The external pressure switch is only monitored if the "system monitoring" function is activated.

#### **3.6.6. Fill level monitoring**

On gear pump units with fill level switch, the fill level is monitored by the control unit. As soon as the fill level of the lubricant reservoir falls below the minimum, the gear pump unit is switched off and a fault message is issued.

If fill level monitoring is installed, it is always active and cannot be deactivated.

#### **3.6.7. System monitoring**

This function allows automatic monitoring of the centralized lubrication system. In case of a fault, e.g. insufficient fill level or insufficient pressure build-up, a fault message is issued and the operational sequence is stopped.

The cause of the malfunction can be shown. The fault hours figure is also stored and can be displayed.

#### **3.6.8. EEPROM non-volatile memory**

The control unit stores the remaining interval time or remaining contact time when the operating voltage is disconnected. The remaining interval time or remaining contact time then resumes once operating voltage is reconnected.

#### **3.6.9. Code protection**

To prevent unauthorized access to the control unit, the control unit can be protected using a three-digit numeric code.

## 4. Assembly instructions

### 4.1. General information

Only qualified technical personnel may install, operate, maintain, and repair the gear pump units with reservoir described in the owner's manual. Qualified technical personnel are persons who have been trained, assigned and instructed by the operator of the final product into which the described gear pump unit with reservoir is incorporated. Such persons are familiar with the relevant standards, rules, accident prevention regulations, and operating conditions as a result of their training, experience, and instruction. They are qualified to carry out the required activities and in doing so recognize and avoid potential hazards.

The definition of qualified personnel and the prohibition against employing non-qualified personnel are laid down in DIN VDE 0105 and IEC 364.

Before assembling/setting up the gear pump unit with reservoir, the packaging material and any shipping braces (e.g., plugs) must be removed. Keep the packaging material until any discrepancies have been resolved.



#### Warning!

The product must not be tilted or dropped. During all assembly work on commercial vehicles or machinery, observe the local accident prevention

regulations as well as the applicable operating and maintenance specifications.

### 4.2. Setup and attachment

The gear pump unit with reservoir should be protected from humidity and vibration, and should be mounted so that it is easily accessible, allowing all further installation work to be done without difficulty. The control screen, if present, must be easily visible and reachable.

Ensure that there is sufficient air circulation to prevent excessive heating of the gear pump unit with reservoir. For the maximum permissible ambient temperature, see "Technical data."



For the product-specific technical data on the gear pump unit with reservoir, see the relevant documentation. If no documentation is available, you can request the documentation directly from SKF Lubrication Systems Germany GmbH.

The mounting position of the gear pump unit with reservoir is vertical as shown in the documentation.

Drill the assembly holes for wall-mounting the gear pump unit with reservoir as specified in → Chapter 4.3, "Connection dimensions."



#### Warning!

During assembly and especially when drilling, always pay attention to the following:

- Existing supply lines must not be damaged by assembly work.
- Other units must not be damaged by assembly work.
- The gear pump unit with reservoir must not be installed within range of moving parts.
- The gear pump unit with reservoir must be installed at an adequate distance from sources of heat.
- Maintain safety clearances and comply with local regulations for assembly and accident prevention.
- Use existing holes on the commercial vehicle frame or other commercial vehicle parts.
- Bridge large holes using body washers.
- Pay attention to steering lock angle, spring action and possible wearing spots during assembly.



#### Warning!

The German Ordinance on the National and International Carriage of Dangerous Goods by Road, Rail and Inland Waterways (GGVSEB) must be observed for tankers and other vehicles that transport hazardous goods.

**Warning!**

Any change to a commercial vehicle, especially the installation of additional equipment such as centralized lubrication systems, must be checked and approved by the competent technical authorities in the operator country. Non-observance can void the license to operate the commercial vehicle.

For the dimensions and location of the fastening holes, see the documentation of the gear pump unit with reservoir. If no documentation is available, the dimensions and location of the fastening holes on the connecting flange can be determined by taking measurements.



If no documentation is available, you can request the documentation directly from SKF Lubrication Systems Germany GmbH.

### 4.3. Connection dimensions

Gear pump units with reservoir are designed for wall mounting (industrial design) or installation on a vehicle (commercial vehicle design). The gear pump unit with reservoir is mounted on a connecting flange with three fastening points. It is fastened using three M8 screws, washers and self-locking nuts. The tightening torque is 16 Nm.

## 4.4. Electrical connection

### 4.4.1. Electric motor connection

Gear pump units with reservoir are driven by electric motors.



#### Danger!

Electrical connections for the gear pump unit may only be established by qualified and trained personnel authorized to do so by the operator, and in observance of the local conditions for connections and local regulations (e.g., DIN, VDE). Incorrectly connected gear pump units with reservoir can cause considerable damage to property and result in serious injury or death.



#### Danger!

The mains voltage (supply voltage) must match the specifications on the rating plate of the gear pump unit. Check the fuse protection of the electrical circuit. Use only fuses with the prescribed amperage, else bodily injury and property damage may result.

**Table 5. General conditions for connections**

Design	Rated voltage	Typical power input (load-dependent) <sup>1)</sup>	Starting current (approx. 20 ms)	Back-up fuse
KFB1... / KFBS1... commercial vehicles	24 V DC	1.1 A	approx. 4.5 A	5.0 A <sup>2)</sup>
	12 V DC	2.1 A	approx. 9.0 A	8.0 A <sup>2)</sup>
KFB1-M... / KFBS1-M... industrial	24 V DC <sup>4)</sup>	1.1 A	approx. 4.5 A	max. 5.0 A <sup>3)</sup>

<sup>1)</sup> Typical value at ambient temperature = 25 °C and operating pressure = 38 bar

<sup>2)</sup> Fuse, e.g. per DIN 72581

<sup>3)</sup> Conductor: cross-section 1.5 mm<sup>2</sup>, length ≤ 12 m

<sup>4)</sup> Protective measures to be taken for operation according to intended use:  
“Functional Extra Low Voltage”; “Protective Extra Low Voltage” (PELV)

**Table 6. Color coding**

Color abbreviation	Wire color
BN	Brown
RD-BK	Red-black
BU	Blue
PK	Pink
BK	Black
VT-GN	Purple-green
WH	White
YE	yellow

#### 4.4.2. KFB1 (commercial vehicles) without internal control unit, without fill level monitoring

The electrical connection is established via a 4-pin circular connector according to DIN 72585-A1-4.1-Ag/K1 (→ Fig. 3 and → Fig. 4).

→ Table 7 contains a list of the cable sets available from SKF.

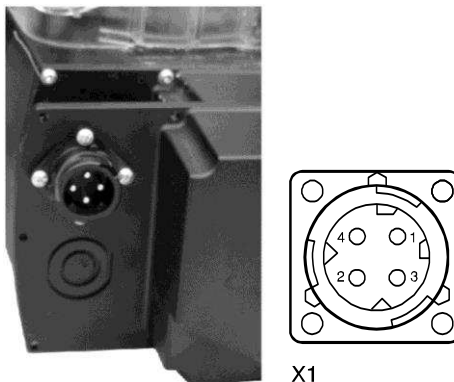

Fig. 3. X1 circular connector acc. to DIN72585-A1-4.1-Ag/K1

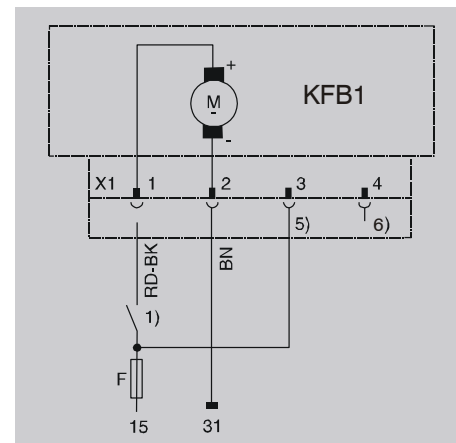

Fig. 4. Electrical connection of KFB1

15 + Supply voltage potential

31 - Supply voltage potential

1) External control unit;  
relay contact "Pump ON"

5) Connection of pushbutton for  
interim lubrication

6) PIN without internal connection  
F Fuse

See → Table 6 for wire colors.

Table 7. SKF cable sets for electrical connection

Unit	Order number	Length	Number of wires	Features
KFB1	997-000-706	10 m	4	Corrugated pipe, for dangerous goods road shipments
KFB1-W, KFBS1, KFBS1-W	997-000-760	8 m	3	Corrugated pipe, for dangerous goods road shipments; for systems without external signal processing (pressure switch, fault notification)
	997-000-904	10 m	7	Corrugated pipe, for dangerous goods shipments; for systems without external signal processing (pressure switch, fault notification)
	997-000-630	12 m	7	Corrugated pipe, for dangerous goods road shipments; for systems with external signal processing (pressure switch, fault notification)
	997-000-650	16 m	7	Corrugated pipe, for dangerous goods road shipments; for systems with external signal processing (pressure switch, fault notification)

#### 4.4.3. KFB1-W (commercial vehicles) without internal control unit, with fill level monitoring

The electrical connection and the fill level switch connection are established via a 7-pin circular connector as shown (➔ Fig. 5 and ➔ Fig. 6). ➔ Table 7 contains a list of cable sets available from SKF.

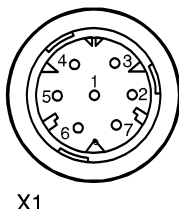

Fig. 5. X1 circular connector

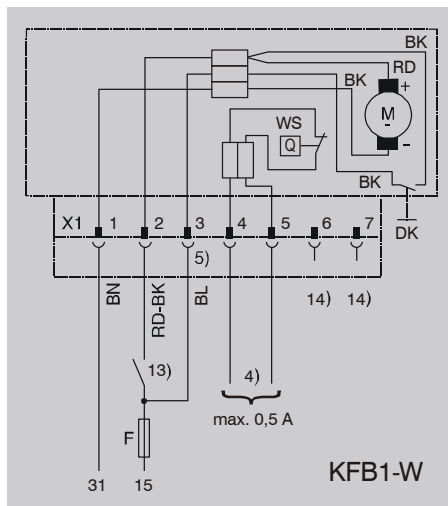

Fig. 6. Electrical connection of KFB1-W

- 15 + Supply voltage potential
  - 31 - Supply voltage potential
  - 4) Evaluation of fill level switch signal
  - 5) Connection of pushbutton for interim lubrication
  - 13) External control unit; relay contact "Pump ON"
  - 14) PIN without internal connection
  - F Fuse
  - WS internal fill level switch
- Position shown: reservoir filled

See ➔ Table 6 for wire colors.

#### 4.4.4. KFBS1, KFBS1-W (commercial vehicles)

##### with integrated control unit and external pressure switch monitoring

The electrical connection and the connection of the external pressure switch to the internal control unit are established via a 7-pin circular connector as shown (→ Fig. 7 and → Fig. 8).

If present, a fill level switch (on KFBS1-W) is monitored by the internal control unit and does not need to be connected. If the fill level in the lubricant reservoir falls below minimum, the fault notification FLL appears on the screen and the operational sequence is stopped.

The external pressure switch is connected via PINs 5 and 6. To activate monitoring, the COP = PS (system monitoring) function must be set in the control unit's programming mode.

→ Table 7 contains a list of the cable sets available from SKF.

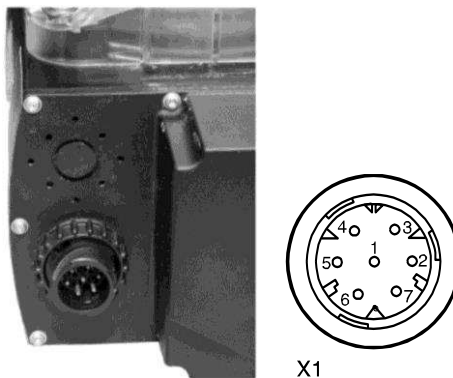

Fig. 7. X1 circular connector

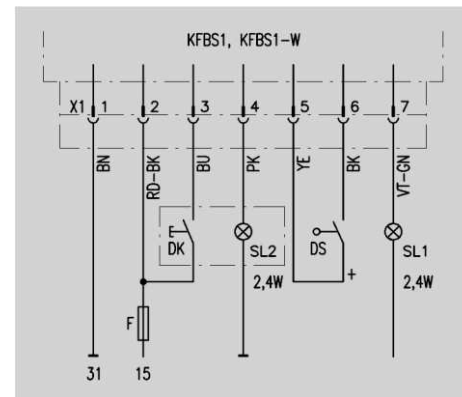

Fig. 8. Electrical connection of KFBS1 and KFBS1-W

- 15 + Supply voltage potential (ignition switch ON)
- 31 - Supply voltage potential (0 V, GND)
- DK External pushbutton for interim lubrication
- DS External pressure switch
- SL1 Signal lamp "Pump ON"
- SL2 Signal lamp "Fault"
- F Fuse

See → Table 6 for wire colors.

#### 4.4.5. KFB1-M (industrial) without internal control unit, without fill level monitoring

The electrical connection is established via a 4-pin plug connector acc. to DIN 175301-803 as shown (→ Fig. 9 and → Fig. 10).

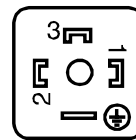

X1

Fig. 9. X1 plug connector Plug connector acc. to DIN 175301-803

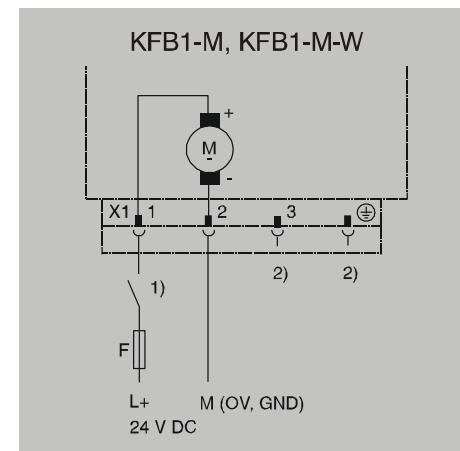

Fig. 10. Electrical connection of KFB1-M

- 1) External control unit;  
relay contact "Pump ON"
- 2) PIN without internal connection
- L+ + Supply voltage potential  
(main machine switch ON)
- M - Supply voltage potential
- F Fuse

See → Table 6 for wire colors.



#### 4.4.6. KFB1-M-W (industrial) without internal control unit, with fill level monitoring

The electrical connection is established via a 4-pin plug connector acc. to DIN 175301-803 as shown (→ Fig. 11 and → Fig. 12). The electrical connection for fill level monitoring is established via a 4-pin X2 circular connector as shown (→ Fig. 13).

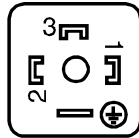

X1

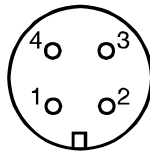

X2

Fig. 11. X1 plug connector Plug connector acc. to DIN 175301-803 for electrical connection  
X2 M12x1 circular connector for electrical connection of fill level monitoring

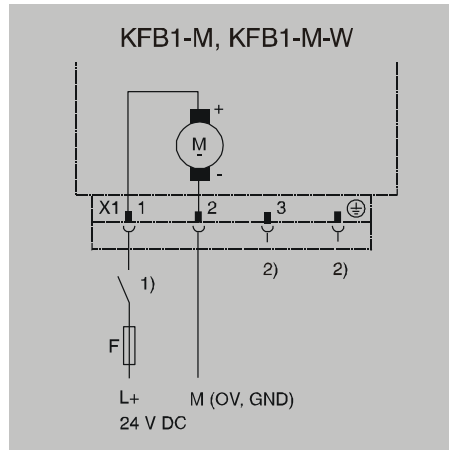

Fig. 12. Electrical connection of KFB1-M-W

- 1) External control unit; relay contact "Pump ON"
  - 2) PIN without internal connection
- L+ + Supply voltage potential (main machine switch ON)  
M - Supply voltage potential  
F Fuse

See → Table 6 for wire colors.

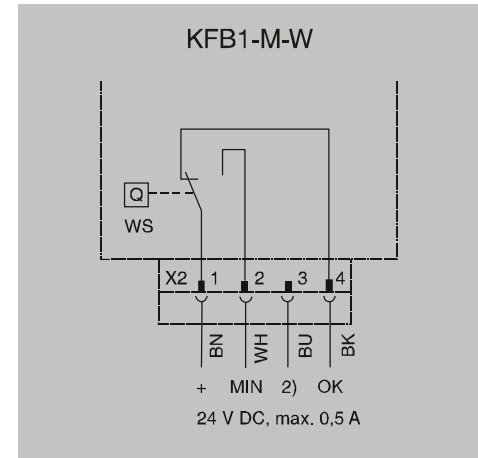

Fig. 13. Connection of fill level monitoring KFB1-M-W

- 2) PIN without internal connection
- WS fill level switch, contact position shown: reservoir filled

See → Table 6 for wire colors.

#### 4.4.7. KFBS1-M, KFBS1-M-W with internal control unit

The electrical connection is established via a 4-pin plug connector acc. to DIN 175301-803 as shown (→ Fig. 14 and → Fig. 15).

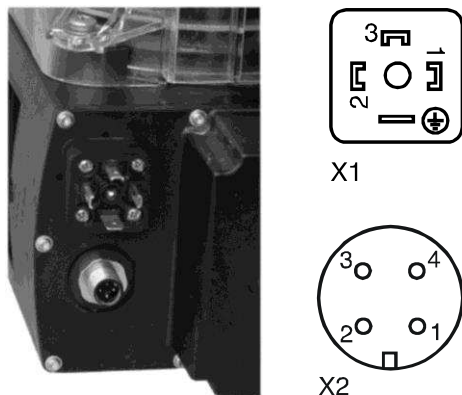

Fig. 14. X1 plug connector  
Plug connector acc. to DIN 175301-803  
for electrical connection  
X2 M12x1 circular connector for electrical  
connection of external pressure switches

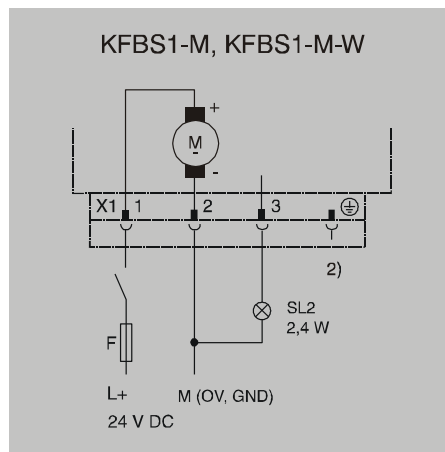

Fig. 15. X1 electrical connection  
KFBS1-M and KFBS1-M-W  
2) PIN without internal connection  
L+ + Supply voltage potential  
(main machine switch ON)  
M - Supply voltage potential  
SL2 Signal lamp "Fault"  
F Fuse

If present, a fill level switch (on KFBS1-M-W) is monitored by the internal control unit and does not need to be connected. If the fill level in the lubricant reservoir falls below minimum, the fault notification FLL appears on the screen and the operational sequence is stopped.

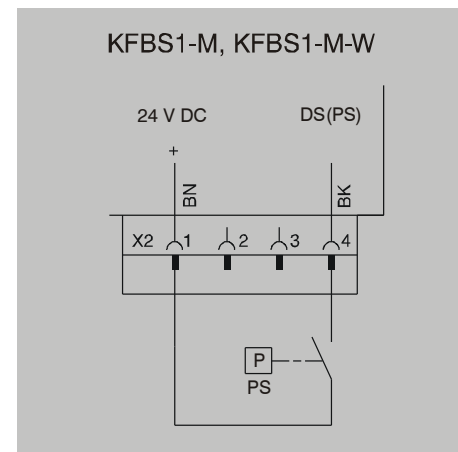

Fig. 16. X2 electrical connection  
KFBS1-M and KFBS1-M-W  
PS Pressure switch

The electrical connection of an external pressure switch is established via a 4-pin X2 circular connector as shown (→ Fig. 16). To activate monitoring, the COP = PS (system monitoring) function must be set in the control unit's programming mode.

#### 4.5. Lubrication line connection

Prior to installation, it is recommended that you fill the lubrication lines with grease or use pre-filled lubrication lines to simplify subsequent venting of the system.

The lubrication lines must be connected to the gear pump unit with reservoir in such a way that no forces can be transferred to the assembled gear pump unit with reservoir (stress-free connection).



##### **Warning!**

The fittings used to connect the lubrication line should be designed for the maximum operating pressure of the gear pump unit with reservoir. If they are not, the lubrication line system needs to be protected from excessive pressure by means of a pressure-limiting valve.

For operating pressures up to 45 bar as can occur especially in single-line piston distributor systems, SKF fittings for solderless pipe unions can be used (double tapered sleeves or tapered sleeves).

Screw in the socket unions of the solderless pipe unions (double tapered sleeves or tapered sleeves) finger-tight and then tighten with 1 1/2 turns.

#### 4.6. Lubrication line arrangement

When arranging the main lubricant lines and lubrication point lines, observe the following instructions in order to ensure that the entire lubrication system functions smoothly.

The main lubricant line must be dimensioned in accordance with the maximum operating pressure occurring in the gear pump unit with reservoir used and the delivery volume of that unit. If possible, the main lubricant line should rise upward from the gear pump unit with reservoir and be ventable at the highest point on the lubrication line system.

Lubricant distributors at the end of the main lubricant line must be installed such that the outlets of the lubricant distributors point upwards. If the system configuration requires that the lubricant distributors be arranged below the main lubricant line, they should not be placed at the end of the main lubricant line.

The pipes, hoses, shutoff valves and directional control valves, fittings, etc. that will be used must be designed for the maximum operating pressure of the gear pump unit with reservoir, the permissible temperatures and the lubricants that will be delivered. The lubrication line system also needs to be protected from excessive pressure by means of a pressure-limiting valve.

All components of the lubrication line system such as pipes, hoses, shutoff valves and directional control valves, fittings, etc. must be carefully cleaned before assembly. No seals in the lubrication line system should protrude inwards in a way that disrupts the flow of the lubricant and could allow contaminants to enter the lubrication line system.

Lubrication lines should always be arranged so that air pockets cannot form anywhere. Avoid changes in the cross-section of the lubrication line from small to large cross-sections in the direction of flow of the lubricant. When the cross-section does change, the transition should be gentle.

The flow of lubricant in the lubrication lines should not be impeded by the incorporation of sharp bends, angle valves, or flap valves. Unavoidable changes in the cross-section in lubrication lines must have smooth transitions. Sudden changes of direction should be avoided if possible.



##### **Warning!**

Lubrication lines must always be free of leaks. Lubricants can contaminate soil and bodies of water. Lubricants must be used and disposed of properly. Observe the local regulations and laws regarding the disposal of lubricants.

**Danger!**

Centralized lubrication systems must always be free of leaks. Leaking lubricant is hazardous due to the risk of slipping and injury. Beware of any lubricant leaking out during assembly, operation, maintenance, or repair of centralized lubrication systems. Leaks must be sealed without delay.

Lubricant leaking from centralized lubrication systems is a serious hazard. Leaking lubricant can create risks that may result in physical harm to persons or damage to other material assets.



Follow the safety instructions on the → lubricant's safety data sheet.

The safety data sheet for a lubricant can be requested from the lubricant manufacturer.

## 5. Transport, delivery, and storage

### 5.1. Transport

SKF Lubrication Systems Germany GmbH products are packaged in accordance with standard commercial practice according to the regulations of the recipient's country and DIN ISO 9001. Safe handling must be ensured during transport. The product must be protected from mechanical effects such as impacts. The transport packaging must be marked "Do not drop!".



#### **Warning!**

The product must not be tilted or dropped.

There are no restrictions for land, air or sea transport.

### 5.2. Delivery

Upon receiving the shipment, please check the product(s) for possible damage, and ensure that the shipment is complete according to the shipping documents. Keep the packaging material until any discrepancies have been resolved.

### 5.3. Storage

SKF Lubrication Systems Germany GmbH products are subject to the following storage conditions:

#### **5.3.1. Storage of lubrication units**

- Ambient conditions: dry and dust-free surroundings, storage in well ventilated dry area
- Storage time: max. 24 months
- Permissible humidity: < 65%
- Storage temperature: 10 - 40°C
- Light: avoid direct sun or UV exposure and shield nearby sources of heat

#### **5.3.2. Storage of electronic and electrical devices**

- Ambient conditions: dry and dust-free surroundings, storage in well ventilated dry area
- Storage time: max. 24 months
- Permissible humidity: < 65%
- Storage temperature: 10 - 40°C
- Light: avoid direct sun or UV exposure and shield nearby sources of heat

#### **5.3.3. Storage - general information**

- The product(s) can be enveloped in plastic film to provide low-dust storage.
- Protect against ground moisture by storing on a shelf or wooden pallet.
- Bright-finished metallic surfaces, especially wearing parts and assembly surfaces, must be protected using long-term anti-corrosive agents before storage.
- At approx. 6-month intervals: Check for corrosion. If there are signs of corrosion, remove them then reapply anti-corrosive agents.
- Drives must be protected from mechanical damage.

## 6. Operation

### 6.1. General information

The gear pump unit with reservoir described functions automatically. You should, however, still observe the following instructions to provide for trouble-free operation:

- Perform a functional check on a regular basis by initiating an interim lubrication.
- Inspect the lubrication of the lubrication points on a regular basis.
- Perform a visual check of the lubricant fill level in the lubricant reservoir at regular intervals (including on gear pump units with fill level monitoring).

If the lubricant fill level is too low, top up to the maximum mark as described in → Chapter 6.2, "Filling the lubricant reservoir."



#### Warning!

The lubricant reservoir must not be completely emptied, as this may result in damage or destruction of the machine components requiring lubrication.

If the lubricant reservoir has been emptied to the point that lubricant no longer flows from the outlets, the entire system must be refilled and then vented (→ Chapter 6.3 "Vent centralized lubrication system.").

### 6.2. Filling the lubricant reservoir



Observe the instructions from the machine manufacturer regarding the lubricants that are to be used.



#### Warning!

Only fill using clean lubricant and an appropriate device. Contaminated lubricants can result in severe system malfunction. The lubricant reservoir must be filled without introducing bubbles.



#### Warning!

Different lubricants must not be mixed together. Doing so can cause damage and require extensive cleaning of the gear pump unit/centralized lubrication system. It is recommended that an indication of the lubricant in use be attached to the lubricant reservoir in order to prevent accidental mixing of lubricants.

The lubricant may only be fed without bubbles. The lubricant reservoir, if present, must be filled with clean lubricant without introducing bubbles.

The filtered lubricant (permissible particle size: < 10 μm) is filled in without bubbles via the filler socket (item 5, → Fig. 1 and Fig. 2) using a filling pump. See the → technical documentation for more information about the filler socket. The lubricant reservoir may only be filled up to the "max." mark.

#### Gear pump units with fill level monitoring

Gear pump units with fill level monitoring possess a follower piston. During initial filling, the lubricant reservoir must be filled until the air trapped in the lubricant reservoir escapes via the overflow outlet and excess lubricant discharges there. It is recommended that the gear pump unit be tilted by 30° – 45° from its horizontal position, as the venting hole will then be at the highest point and the air can escape without lubricant discharging.

### 6.3. Vent centralized lubrication system.



#### Warning!

The lubricant may only be fed without bubbles. Air pockets in the lubricant adversely affect the function of the gear pump unit and impair the reliability of lubricant delivery, which can result in damage to the lubrication points requiring lubrication.

The process of venting the centralized lubrication system can be facilitated by:

- Opening the ends of the main lubricant line until bubble-free lubricant discharges from the ends.
- Filling long lubricant line sections before connecting.

The centralized lubrication system is vented as follows:

- **Disconnect the main lubricant lines from the gear pump unit. Operate the gear pump until the lubricant emerging from the pressure regulating valve is free of bubbles. Reinstall the main lubricant lines.**
- **Disconnect main lubricant line from master distributor. Operate the gear pump until the lubricant emerging is free of bubbles. Reinstall the main lubricant line.**
- **Disconnect lubricant branch lines from master distributor. Operate the gear pump unit until bubble-free lubricant emerges from all ports of the master distributor. Reinstall the lubricant branch lines.**
- **Finally, vent the lubricant branch lines, secondary distributors, lubricant lines, and lubrication points, and check for proper functioning.**

## 7. Operation

### 7.1. Gear pump units without internal control unit

Gear pump units for commercial vehicles with external control unit are equipped with a pushbutton to trigger an interim lubrication (item 7, → Fig. 1).

All other operating functions and display of the operating state are performed via the external control unit. The associated → operating instructions must be observed.

### 7.2. Gear pump units with internal control unit

The operation of gear pump units with internal control unit is described in the → following chapter.



## 8. Electronic control unit

### 8.1. Display and control elements

The gear pump unit with reservoir is operated via a control screen (→ Fig. 17). The display and control elements are explained in

→ Table 8. → Table 9 contains an overview of the display options of the three-digit LED display.

The control screen is protected against splashwater and mechanical damage by a transparent plastic cover. In order to operate the gear pump unit, remove the cover using a screwdriver.

The layout of the control screen has changed since 2007. See → Table 8 for a comparison of the display and control elements of the new control screen with those of the old one.

### 8.2. Pushbutton operation

#### 8.2.1. Button (DK)

By pressing this button, the lubrication procedure is started with the programmed parameters independently of the current system status.

The control screen is not switched on, and any currently active display or programming mode is interrupted. At the same time, any pending fault messages are cleared.



Prior to clearing pending fault messages, first read them on the control screen to ensure smooth operation by determining and rectifying the cause of the fault.

#### 8.2.2. Button (UP)

A brief press of this button while the control screen is off activates display of current parameters and their values (display mode). Each additional brief press of this button causes the next value or parameter to be displayed. See → Table 16, Chapter 8.4.2, "Display mode" for the sequence of displays. After the last value has been shown, the control screen switches off again.

A brief press in programming mode calls the next parameter or increments the displayed value.

#### 8.2.3. Button (DOWN)

Pressing the button while the control screen is off activates display of current values and parameters (display mode). The displays can then be consecutively called via the  button.

A brief press in programming mode calls the preceding parameter or decrements the displayed value.

#### 8.2.4. Button (SET)

A long press (> 3 s) while the screen is off activates programming mode. Any currently running lubrication procedure is interrupted.

During programming, this button can be used to select and confirm parameters and values. Upon confirmation of a value, this value is immediately stored in the memory of the control unit.

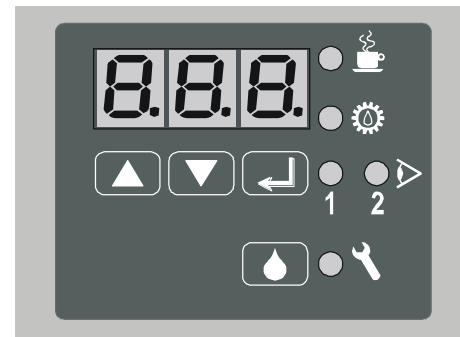

Fig. 17. Display and operating unit

A long press (> 3 s) during programming mode terminates this mode and starts the programmed interval time of the lubrication cycle.

Table 8. Display and control elements of control screen



















Symbol		Description	Function
Old screen	New screen		
		3-digit LED display	Display of operating parameters and user guidance for programming.
		PAUSE LED	Indicates interval time. Display mode: Lights up when operating voltage is present and during the interval time. Programming mode: Flashes when the value for the interval time is being changed.
		CONTACT LED	Display of the contact time. Display mode: Lights up when operating voltage is present and during the contact time. Programming mode: Flashes when the value for the contact time is being changed.
		CS LED	Not assigned.
		PS LED	Indicates monitoring of an external pressure switch. Display mode: Lights up during the contact time when system monitoring is activated and an external pressure pressure switch is connected. Programming mode: Flashes when switching the monitoring function on or off.
		FAULT LED	Indicates a fault Lights up when operating voltage is present and an error has occurred in the operational process. The operational sequence has been stopped.
		DK button	Brief press during the INTERVAL: Starts a lubrication procedure. Brief press during fault: Fault message is acknowledged and cleared.
		UP button	Brief press when screen is off: Activates display mode. Brief press in display mode: Opens the next parameter or value. Long press (> 3 s) in display mode: Switches off the screen. Brief press in programming mode: Opens the following parameter or increments the displayed value by 1.
		DOWN button	Brief press when screen is off: Activates display mode. Brief press in programming mode: Opens the preceding parameter or decrements the displayed value by 1.
		SET button	Long press when screen is off: Activates programming mode. Long press (> 3 s) in display mode: Switches off the screen. Brief press in programming mode: Selects parameters and values and confirms them. Long press (> 3 s) in programming mode: Terminates programming mode.

Table 9. Explanation of display contents of the three-digit LED display

Display	Explanation of characters	Explanation	Value range	Factory setting
t P A	t = TIMER PA = PAUSE	"Interval time in timer mode" parameter. The length of the interval is time-dependent. The following figures indicate the duration of the interval.	00.1 - 99.9 hours	10 hours
c P A	c = COUNTER PA = PAUSE	"Interval time in counter mode" parameter. The length of the interval is pulse-dependent. The following figures indicate the duration of the interval.	001 - 999 pulses	-
t C O	t = TIMER CO = CONTACT	"Contact time in timer mode" parameter. The length of the contact time is time-dependent. The following figures indicate the duration of the contact time.	00.1 - 99.9 minutes	2.0 minutes (minimum value)
c C O	c = COUNTER CO = CONTACT	"Contact time in counter mode" parameter. The length of the contact time is pulse-dependent. The following figures indicate the duration of the contact time.	001 - 999 pulses	-
C O P	C = CYCLE O = OFF P = PRESSURE	"Monitoring function" parameter	OFF - System monitoring is deactivated CS - Not assigned PS - System monitoring is activated	-
OFF	OFF = OFF	System monitoring is deactivated.	-	-
CS	Cycle Switch	Not assigned.	-	-
PS	Pressure Switch	System monitoring is activated.	-	-

Continuation of Table 9. Explanation of display contents of the three-digit LED display

Display	Explanation of characters	Explanation	Value range	Factory setting
<b>FLL</b>	Fault Low Level	Indicates a fault. The minimum fill level has been reached in the reservoir. The FAULT LED lights up and the operational sequence is stopped.	-	-
<b>Oh</b>	Operation hour meter	Operation hour meter. The following figures indicate the operation hours of the control unit. Two display values appear. Display 1: The first three digits of the value Display 2: The last two digits and one decimal place	00000.0 - 99999.9 hours	00000.0 hours
<b>Fh</b>	Fault hour meter	Fault hour meter. The following figures indicate the fault hours of the control unit. Two display values appear. Display 1: The first three digits of the value Display 2: The last two digits and one decimal place	00000.0 - 99999.9 hours	00000.0 hours

## 8.3. Programming

### 8.3.1. Start programming mode







Programming mode can only be opened if the display is off.

Long press (> 3 s) the  button to switch on the screen and start programming mode.

When programming mode is activated, any currently active lubrication procedure is interrupted. After exiting programming mode, a new lubrication cycle is started with the current values and parameters if no fault message is present. The lubrication cycle starts with the interval time.

During programming, the PAUSE, CONTACT, or PS LEDs flash, depending on the parameters that are currently being adjusted.

**Table 10. Start programming mode**

Step	Button	Action	Display
1		Press longer than 2 s.	 <p>000 is displayed. Display flashes</p>
Step 2 follows if the factory-set programming code 000 has already been changed, otherwise go straight to step 3.			
2	 	Press repeatedly until the current programming code is set.	 <p>The current programming code is displayed. <b>Example:</b> 666 The three-digit LED display flashes.</p>
3		Press briefly (confirm code).	 <p>The first adjustable parameter is displayed. <b>Example:</b> Interval time in timer mode The PAUSE LED flashes.</p>

### 8.3.2. Change operating mode

First activate programming mode (→ Table 10).  
Upon confirmation of the code, the operating mode of the interval time is displayed as the first adjustable parameter.

Set the operating mode of the interval time and contact time as described in the → adjacent table. The PAUSE or CONTACT LEDs will flash while you make the changes.











Changeover of contact time to counter mode is reserved for special cases. Contact SKF.

See → Chapter 3.6.4 "Modes of operation" for more information concerning the available operating modes. Observe the value ranges in the → "Technical data" or in the → Technical Documentation.



If no documentation is available, you can request the documentation directly from SKF Lubrication Systems Germany GmbH.

**Table 11. Change operating mode**

Step	Button	Action	Display
			 <p>Programming mode is active. The first adjustable parameter is displayed. <b>Example:</b> Interval time in timer mode The PAUSE LED flashes.</p>
1		Press briefly.	 <p>The display changes from tPA to cPA tPA – Interval time in timer mode (value in hours) cPA – Interval time in counter mode (values in pulses) The PAUSE LED flashes.</p>
2		Press briefly to confirm new setting.	 <p>Display the next parameter. <b>Example:</b> Contact time in timer mode The CONTACT LED flashes.</p>
3		Press briefly.	 <p>The display changes from tCO to cCO or vice versa. tCO – Contact time in timer mode (values in hours) cCO – Contact time in counter mode (values in pulses) CONTACT LED flashes.</p>
4		Press briefly.	New settings are confirmed.
5		Press longer than 2 s.	The display clears; the new setting is stored.

### 8.3.3. Set interval time and contact time

First activate programming mode (➔ Table 10).

Upon confirmation of the code, the operating mode of the interval time is displayed as the first adjustable parameter.















Set the intervals and the contact times as described in ➔ adjacent table. The PAUSE or CONTACT LEDs will flash while you make the changes.

Observe the value ranges in the "Technical data" or in the ➔ Technical Documentation.



If no documentation is available, you can request the documentation directly from SKF Lubrication Systems Germany GmbH.

**Table 12. Set interval time and contact time.**

Step	Button	Action	Display	
				Programming mode is active. The first adjustable parameter is displayed. <b>Example:</b> Interval time in timer mode The PAUSE LED flashes.
1		Press briefly. (select the parameter)		The current value for the interval time is displayed. <b>Example:</b> 10 h PAUSE LED flashes.
2	 	Press repeatedly until the desired value is set.		The new value is displayed. <b>Example:</b> 6.8 h = 6 h 48 min The PAUSE LED flashes.
3		Press briefly. (confirm the new value)		Display the next parameter. <b>Example:</b> Contact time in timer mode The CONTACT LED flashes.  The new value for the "interval time" parameter has been confirmed and stored in the control unit's non-volatile memory.
4		Press briefly.		The value for the contact time is displayed. <b>Example:</b> 2 min (factory setting) CONTACT LED flashes.
5	 	Press repeatedly until the desired value is set.		The new value is displayed. <b>Example:</b> 3 min The CONTACT LED flashes.
6		Press briefly.		New settings are confirmed.
7		Press longer than 2 s.		The display clears; the new setting is stored.

### 8.3.4. Switch monitoring function on/off

First activate programming mode (→ Table 10).  
Upon confirmation of the code, the operating mode of the interval time is displayed as the first adjustable parameter.

Switch system monitoring on or off as described in the → adjacent table. The PS and CS LEDs will flash while you make the changes.

Observe the value ranges in the "Technical data" or in the → Technical Documentation.



If no documentation is available, you can request the documentation directly from SKF Lubrication Systems Germany GmbH.













#### Warning!

Selection of the CS value is not permitted on the gear pump units described here.



The PS setting may only be activated if a pressure switch is installed in the system and has been connected to the cable set of the gear pump unit.

**Table 13. Switch monitoring function on/off**

Step	Button	Action	Display
			 <p>Programming mode is active. The first adjustable parameter is displayed. <b>Example:</b> Interval time in timer mode The PAUSE LED flashes.</p>
		Press repeatedly until COP is displayed.	 <p>The "monitoring function" parameter is displayed. The CS and PS LEDs flash.</p>
		Press briefly. (select the parameter)	 <p>The current value for the "monitoring function" parameter is displayed. <b>Example:</b> OFF (system monitoring off).</p>
		Press either until the desired function is set.	<p>The display changes between OFF, CS, and PS. The respective LED flashes. <b>Warning!</b> The setting CS is not permitted.</p>  
		Press briefly. (confirm the new value)	<p>The new setting has been confirmed and stored in the control unit's non-volatile memory.</p>
		Press longer than 2 s.	<p>The display clears. A new lubrication cycle is started beginning with the interval time.</p>



### 8.3.5. Change programming code

The programming code prevents settings on the control unit from being adjusted accidentally. It must be entered in order to access programming mode.



Setting a new programming code deletes the factory default programming code and activates the new value. Write down the new value and store it in a safe place. The parameters cannot be programmed if the programming code is lost or forgotten. In this case, the gear pump unit must be sent to the dealer or authorized SKF branch office.



#### Warning!

Do not enter the digits 321 as the new programming code.

**Table 14. Change programming code**

Step	Button	Action	Display	
1		Press longer than 2 s.		000 is displayed. The three-digit LED display flashes.
2	 	Press either until 321 is set.		The key code 321 is displayed. The three-digit LED display flashes.
3		Press briefly (confirm key code).		The display returns to 000. The three-digit LED display flashes.
If the programming code has already been changed, it must be entered again before making another change. Proceed with step 5 if you want to reprogram the code.				
4	 	Press either until the old code is set.		The old code is displayed. <b>Example:</b> 333 The three-digit LED display flashes.
5		Press briefly (confirm old code or factory setting).		Display the factory setting 000 or the new code, <b>Example:</b> 333 The three-digit LED display flashes.
6	 	Press either until the new code is set.		The new code is displayed. <b>Example:</b> 666 The three-digit LED display flashes. <b>Warning!</b> Do not enter 321.
7		Press briefly (confirm new code).		The new value for the programming code has been confirmed and stored in the control unit's non-volatile memory.
8		Press longer than 2 s.		The display clears. A new lubrication cycle is started beginning with the interval time.







## 8.4. Operation

### 8.4.1. LED displays on the control screen during operation

During operation, you should regularly check the LED displays on the control unit's control screen (→ Table 15).

Further information about the operating state and the set parameters can be queried in display mode (→ next Chapter).

**Table 15. LED displays on the control screen during operation**

LED	LED lights up
	Operating voltage is present on the gear pump unit and the control unit. The centralized lubrication system is currently in the interval time.
	Operating voltage is present on the gear pump unit and control unit. The centralized lubrication system is currently in the contact time.
	During the contact time: System monitoring is active.
	Not assigned
	Fault The operational sequence has been stopped.  Additional information can be accessed by pressing  or  (→ Chapter 8.5, "Faults").

### 8.4.2. Display mode

During normal operation, the three-digit LED display is switched off and, depending on the operating state, only the PAUSE, CONTACT, PS, or FAULT LEDs light up (→ preceding Chapter).

To display the current operating parameters, the three-digit LED display is activated by briefly pressing one of the two buttons ▲ or ▼. The LED display is then in display mode.

In display mode, you can query the current parameters and their values one by one. The procedure is shown in → Table 16.













→ Table 9 in → Chapter 8.1, "Display and control elements" shows an overview of the possible display contents, their meaning and the value range.

**Table 16. Display of parameters in display mode**

Step	Button	Display	
1	Press ▲ .. ▼ briefly.		Display mode is activated. The current operating state is displayed. <b>Example:</b> Interval time in timer mode
2	▲		Display of remaining interval time in the current lubrication cycle <b>Example:</b> 3.8 h If a lubrication procedure is currently being executed (CONTACT LED lights up), --- is displayed.
3	▲		Display of the programmed total interval time <b>Example:</b> 10 h
4	▲		Switchover to the "contact time" parameter. <b>Example:</b> Contact time in timer mode
5	▲		Display of the remaining contact time for current lubrication cycle <b>Example:</b> The centralized lubrication system is currently in the interval time; the remaining contact time therefore cannot be displayed.
6	▲		Display of the programmed total contact time <b>Example:</b> 2.0 min
7	▲		Switchover to the "monitoring function" parameter.

Continued on next page

Continuation of Table 16. Display of parameters in display mode

Step	Button	Display	
8			Display of the system monitoring status. <b>Example:</b> Monitoring using an external pressure switch is switched on.
9			Operation hour meter The operation hours are displayed in two parts: The number of operation hours results from combining the two parts.
10 / 11	 		<b>Example:</b> Display 1: 005,    Display 2: 33.8; Operation hours: 533.8 h
12			Fault hour meter The fault hours are displayed in two parts: The number of fault hours results from combining the two parts.
13 / 14	 		<b>Example:</b> Display 1: 000,    Display 2: 33.8 Fault hours: 33.8 h
15		The display clears.	

## 8.5. Faults

### 8.5.1. Display of faults



When system monitoring is active and depending on whether the gear pump unit is equipped with a fill level switch, the electronic control unit will display the following faults (→ Table 17).

#### Fault indication

- FAULT LED lights up.

#### Read fault messages

The fault message can be read on the control screen in view mode:

- Briefly press  or  to activate display mode.
- Press  until a fault message is displayed.

### 8.5.2. Clear fault messages

The fault messages are acknowledged and cleared by pressing the  button. At the same time, a new lubrication procedure is started.



#### Warning!

Prior to clearing a fault message, the cause of the fault must be determined and rectified.

### 8.5.3. Fault hour meter

The time which has elapsed between the occurrence of the fault message and the rectification of the fault is stored in the non-volatile memory of the control unit as a fault hours figure.

When this is done, all fault state-times counted during the entire operating time of the gear pump unit are summed. The current count can be read as described in → Chapter 8.4.2, "Display mode."

The memory cannot be deleted.

Table 17. KFBS fault messages

Display	Meaning
<b>FPS</b>	Fault: Pressure Switch The external pressure switch does not open or close as expected, i.e., there is insufficient pressure build-up in the main lubricant line.
<b>FLL</b>	Fault Low Level: The minimum fill level in the lubricant reservoir has been reached.

## 9. Shutdown

### 9.1. Temporary shutdown

The described product can be temporarily shut down by disconnecting the electrical and hydraulic supply connections. The instructions in → Chapter 1, "Safety instructions" in this owner's manual must be observed when doing so.

If the product is to be shut down for an extended period of time, follow the instructions in → Chapter 5, "Transport, delivery, and storage" in this owner's manual.

To recommission the product, follow the instructions in → Chapter 4, "Assembly" and → Chapter 6, "Operation" in this owner's manual.

### 9.2. Permanent shutdown

If the product will be permanently shut down, the local regulations and laws regarding the disposal of contaminated equipment must be observed.



#### **Warning!**

Lubricants can contaminate soil and bodies of water. Lubricants must be used and disposed of properly. Observe the local regulations and laws regarding the disposal of lubricants.

The product can also be returned to SKF Lubrication Systems Germany GmbH for disposal, in which case the customer is responsible for reimbursing the costs incurred.

## 10. Maintenance

### 10.1. General notes

**Danger!**

Performing work on an energized pump or product may result in serious injury or death. Assembly, maintenance, and repair work may only be performed on products that have been de-energized by qualified technical personnel. The supply voltage must be switched off before opening any of the product's components.

**Danger!**

Centralized lubrication systems are pressurized during operation. Centralized lubrication systems must therefore be depressurized before starting assembly, maintenance or repair work, or any system modifications or system repairs.

**Danger!**

The described product is pressurized during operation. The product must therefore be depressurized before starting assembly, maintenance or repair work, or any system modifications or system repairs.

Products from SKF Lubrication Systems Germany GmbH are low-maintenance. However, all connections and fittings must be regularly inspected for proper seating to ensure proper function and to prevent hazards from arising.

SKF Lubrication Systems Germany GmbH shall not be held liable for damages resulting from improperly performed assembly, maintenance or repair work on the product.

### 10.2. Cleaning

If necessary, the product can be cleaned using mild cleaning agents that are compatible with the product's materials (non-alkaline, non-soap). For safety reasons, the product should be disconnected from the power supply and the hydraulic and/or compressed air supply.

Do not allow any cleaning agent to enter the interior of the product during cleaning.

It is not necessary to clean the interior of the product if the product is operated normally and intercompatible lubricants are used.

The interior of the product must be cleaned if incorrect or contaminated lubricant is accidentally filled into the product. If this occurs, please contact the Service department of SKF Lubrication Systems Germany GmbH for assistance.



Dismantling of the product or individual parts thereof within the statutory warranty period is not permitted and voids any claims.

## 11. Faults

### 11.1. Fault indications on gear pump units without control unit

#### 11.1.1. Gear pump units without fill level monitoring (KFB)

These gear pump units are not equipped with a display function for faults. Operational malfunctions can only be detected by external monitoring (visual or sensory).

#### 11.1.2. Gear pump units with integrated fill level monitoring (KFB..-W)

When using these gear pump units, an insufficient fill level in the lubricant reservoir is indicated by a signal issued via one of the electrical connectors (→ Chapter 4.4, "Electrical connection").

### 11.2. Fault analysis and rectification

→ Table 18 provides an overview of possible malfunctions and their causes. Contact the Service department of SKF Lubrication Systems Germany GmbH if you cannot remedy the malfunction.

**Table 18. Fault analysis and rectification**

Malfunction	Possible cause	Rectification
Electric motor does not start.	No operating voltage at the motor, pump blocked.	Have an electrician perform the following: <ul style="list-style-type: none"> <li>○ Check electrical connection.</li> <li>○ Check operating voltage on motor.</li> <li>○ Check fuse.</li> </ul>
Gear pump unit does not convey lubricant; no pressure build-up	Insufficient fill level.	Top up lubricant. (→ Chapter 6.2, "Filling the lubricant reservoir") Check fill level switch, if installed.
	Wrong lubricant (→ Chapter 2, "Lubricants").	Replace lubricant in the entire centralized lubrication system; beforehand, remove all old lubricant and dispose of it properly.
	Air in the centralized lubrication system.	Vent centralized lubrication system. Lubricant must discharge without bubbles at the lubricant outlet.
During operation, the lubrication points are supplied insufficiently or not at all.	Metering volume too low.	Reduce interval time.
	Air in the centralized lubrication system.	Vent centralized lubrication system. The lubricant must discharge without bubbles at the lubricant outlet (→ Chapter 6.3, "Vent centralized lubrication system.>").
	Main lubricant line too long, cross-section too small (pressure regulating valve opens).	Check the lubricant transport through the main lubricant line and, if required, relocate the gear pump unit.
	Wrong lubricant (→ Chapter 2, "Lubricants").	Replace lubricant in the entire centralized lubrication system; beforehand, remove all old lubricant and dispose of it properly.
	Lubrication line leaky	Check connections.
	Gear pump unit is worn out.	Replace entire gear pump unit.
	Distributor defective.	Replace distributor.
Excessive lubricant at all lubrication points	Metering volume too high.	Increase interval time.



Continuation of Table 18. Fault analysis and rectification

Malfunction	Possible cause	Rectification
Individual lubrication points are not supplied	Lubrication line is clogged.	Clean lubrication lines.
	Lubrication line bent or broken.	Replace affected lubrication lines, insert filled lubrication lines.
	Distributor defective.	Replace distributor.
	Lubrication line too long.	Relocate the gear pump unit, shorten lubrication lines (max. 10 m).
Individual lubrication points receive insufficient or excessive lubrication.	Metering volume too low or too high.	Adapt metering volume to requirement of the lubrication point. Please contact SKF.

**Danger!**

Performing work on an energized pump or product may result in serious injury or death. Assembly, maintenance, and repair work may only be performed on products that have been de-energized by qualified technical personnel. The supply voltage must be switched off before opening any of the product's components.

**Danger!**

The hot surface of a motor may cause burns. Motor surfaces may only be touched with appropriate gloves or after the motor has been shut off for an extended time.

**Danger!**

Centralized lubrication systems are pressurized during operation. Centralized lubrication systems must therefore be depressurized before starting assembly, maintenance or repair work, or any system modifications or system repairs.



Dismantling of the product or individual parts thereof within the statutory warranty period is not permitted and voids any claims.



Only original spare parts from SKF Lubrication Systems Germany GmbH may be used. Unauthorized alterations to products and the use of non-original spare parts and accessories are not permitted.



All assembly, maintenance and repair work beyond this scope must be performed by the Service department of SKF Lubrication Systems Germany GmbH.

## 12. Technical data

Table 19. Technical data

Description	KFB(S)1-M... (industrial design)	KFB(S)1... (commercial vehicle design)
<b>Gear pump unit</b>		
Max. operating pressure	38 bar	38 bar
Permissible operating temperature	0 to +60 °C	-25 °C to +75 °C
Number of outlets	1	1
Delivery rate <sup>1)</sup>	0.05 l/min	0.05 l/min
Lubricant reservoir capacity <sup>2)</sup>	1 l (KFB(S)1-M-W.), 1,4 l (KFB(S)1-M..)	1 l (KFB(S)1-W.), 1,4 l (KFB(S)1..)
Lubricant	Fluid grease NLGI Grade 00 and 000	Fluid grease NLGI Grade 00 and 000
<b>Protection class according to DIN 40050 T9</b>		
Protection class	IP65	IP6K9K
<b>Electrical values for DC motor</b>		
Rated voltage	24 V DC	12 / 24 V DC
Power consumption <sup>3)</sup>	5 A	8 / 5 A
Operating mode/ON-time	S3 / 4% - 60 min max. contact time 2.5 min, min. interval time 1 h	S3 / 2.5% - 120 min max. contact time 3.0 min, min. interval time 2 h
Main lubricant line	Ø 8x1.25; max. 16 m long	Ø 10x1.25; max. 16 m long

Continuation of Table 19. Technical data

Description	KFB(S)1-M... (industrial design)	KFB(S)1... (commercial vehicle design)
<b>IG502-2-I control unit with operating unit and screen (only KFB(S)1-... and KFB(S)1...)</b>		
Interval time, adjustable (see operating mode)	0.1...99.9 / 1...999 h / pulses permissible 1.0...99.9 h Factory setting: tPA = 10 h	0.1 ... 99.9 / 1 ... 999 h / pulses permissible 2.0 ... 99.9 h Factory setting: tPA = 10 h
Contact time (pump cycle time), adjustable (see operating mode)	0.1 ... 99.9 min KFB(S)1-M: permissible 0.1 ... 2.5 min KFB(S)1-M-W: permissible 0.6 ... 2.5 min Factory setting: tCO = 2 min	0.1 ... 99.9 min KFB(S)1: permissible 0.1 ... 3.0 min KFB(S)1-W: permissible 0.6 ... 3.0 min Factory setting: tCO = 2 min
Operation hour meter	0.1 ... 99999.9 h (not deletable) Factory setting: 0.0 h	0.1 ... 99999.9 h (not deletable) Factory setting: 0.0 h
Fault hour meter	0.1 ... 99999.9 h (not deletable) Factory setting: 0.0 h	0.1 ... 99999.9 h (not deletable) Factory setting: 0.0 h
Monitoring of external pressure switches, adjustable	COP = PS (monitoring is active) COP = OFF (monitoring is inactive) Factory setting: COP = OFF	COP = PS (monitoring is active) COP = OFF (monitoring is inactive) Factory setting: COP = OFF
Modes of operation	Counter or timer mode Factory setting: Timer mode	Counter or timer mode Factory setting: Timer mode
<b>Fill level switch (only KFB1-M-W.. and KFB1-W..) <sup>4)</sup></b>		
Rated voltage	24 V DC	24 V DC
Switched current, max.	0.5 A	0.5 A
Switching capacity, max.	20 W	20 W
Function	NC contact	NC contact

<sup>1)</sup> relative to back pressure p = 10 bar and T = 25 °C<sup>2)</sup> due to the follower piston in the lubricant reservoir when fill level switches are used<sup>3)</sup> with operating pressure of 38 bar and ambient temperature T = 25 °C<sup>4)</sup> on KFB(S)1-M-W.. and KFB(S)1-W, the fill level switch is wired internally to the control unit

**Order number: 951-170-009**

**Subject to changes in contents and technical information.**

Last modified: 18.07.2018

The contents of this publication are the copyright of the publisher and may not be reproduced in whole or in part without permission of SKF Lubrication Systems Germany GmbH. Every care has been taken to ensure the accuracy of the information contained in this publication. However, no liability can be accepted for any loss or damage whether direct, indirect or consequential, arising out of use of the information contained herein.

All SKF Lubrication Systems Germany GmbH products may be used only for their intended purpose as described in this owner's manual with associated operating instructions. If assembly/operating instructions are supplied together with the products, they must be read and followed.

Not all lubricants can be fed using centralized lubrication systems. SKF can, on request, inspect the suitability of the lubricants selected by the user for pumping in centralized lubrication systems. Lubrication systems and their components manufactured by SKF Lubrication Systems Germany GmbH are not approved for use in conjunction with gases, liquefied gases, pressurized gases in solution, vapors or such fluids whose vapor pressure exceeds normal atmospheric pressure (1013 mbar) by more than 0.5 bar at their maximum permissible temperature.

Hazardous materials of any kind, especially the materials classified as hazardous by CLP Regulation EC 1272/2008 may only be used to fill SKF centralized lubrication systems and components and delivered and/or distributed with the same after consulting with and receiving written approval from SKF.

**SKF Lubrication Systems Germany GmbH**

Berlin Plant  
Motzener Strasse 35/37  
12277 Berlin  
Germany  
Tel. +49 (0)30 72002-0  
Fax +49 (0)30 72002-111

Hockenheim Plant  
2. Industriestrasse 4  
68766 Hockenheim  
Germany  
Tel. +49 (0)62 05 27-0  
Fax +49 (0)62 05 27-101

lubrication-germany@skf.com  
www.skf.com/lubrication

© SKF is a registered trademark of the SKF Group.  
© SKF Group 2018

